

液晶模组说明书

LCD Module Instructions

初定规格 Preliminary specification

正式规格 Official specifications

项目编号 Project No.	TFT-H055A61HDINVKN50 TFT-H055A61HDINV8C50
产品描述 Product Description	TFT LCD Module 720 x 3RGB x 1280 Dots 5.5 Inch TFT LCD

客户确认签章:

Signature by customer:

小批量试产 Trial Production 大批量生产 Mass Production

请返回一份带有您的签名和评论的确认副本

Please return one copy confirmation with signature and your comments

鑫洪泰科技（广东）有限公司

深圳市鑫洪泰电子科技有限公司

广东省东莞市凤岗镇东深公路凤岗段 208 号天安数码城 N3 栋 3 楼

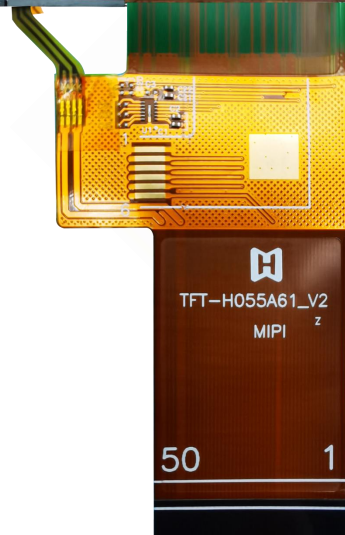

正面 FRONT



背面 Back

TFT-H055A61HD INVKN50_V2-0



正面 FRONT



背面 Back

TFT-H055A61HD INV8C50_V2-1

一、基本特征 General Feature:

项目 Item	标准值 Standard Value			单位 Unit
显示尺寸 Display Size	5.5			英寸 Inch
分辨率 Number of Pixels	720 (H) *3(RGB)* 1280 (V)			点 dots
显示区域 Active Area	68.04 (H) * 120.96 (V)			毫米 mm
外形尺寸 Outline Dimension	70.60(H) * 128.25(V) * 3.52(D)<TFT> 76.00(H) * 140.00(V) * 4.85(D)<TFT+CTP>			毫米 mm
观看方向 Viewing Direction	全视角 FULL 0'clock			-
端口 Interface	MIPI 4 Lane			-
驱动芯片 Driver IC	NV3051			-
驱动电压 Driver Condition	VCI=3.3V(Typ)			伏 V
背光 Backlight	白色 LED/14 颗/2 颗串联 7 路并联 White LED/14 PCS/2 PCS serial 7 ways parallel			-
触摸屏 Touch Panel	<input checked="" type="checkbox"/> 不带触摸屏 Whitout TP	<input type="checkbox"/> 带电阻触摸屏 With RTP	<input checked="" type="checkbox"/> 带电容触摸屏 With CTP	-
电容触摸屏驱动芯片 CTP Driver IC	GT911			-
电容触摸屏驱动电压 CTP Driver Condition	TP-VDD=3.3V			伏 V
TFT 液晶工作温度 TFT Operation Temp	-30 ~ +70			摄氏度 ℃
TFT 液晶储存温度 TFT Storage Temp	-30 ~ +80			摄氏度 ℃

注释 Note:

二、外形尺寸 Outline Dimensions

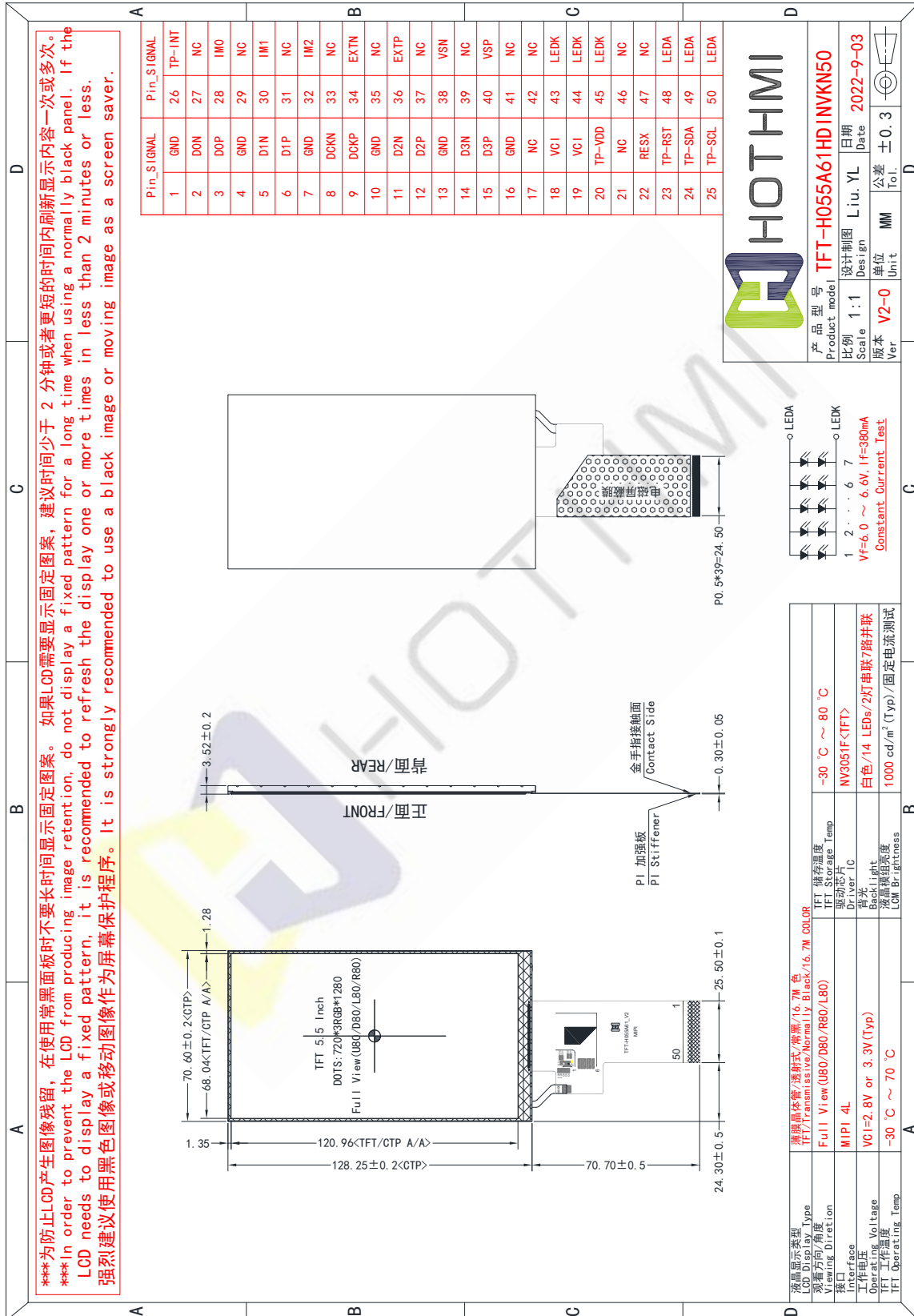

***为防止LCD产生图像残留，在使用常黑面板时不要长时间显示固定图案。如果LCD需要显示固定图案，建议时间少于2分钟或者更短的时间内刷新显示内容一次或多次。
 ***In order to prevent the LCD from producing image retention, do not display a fixed pattern for a long time when using a normally black panel. If the LCD needs to display a fixed pattern, it is recommended to refresh the display one or more times in less than 2 minutes or less.
 强烈建议使用黑色图像或移动图像作为屏幕保护程序。It is strongly recommended to use a black image or moving image as a screen saver.

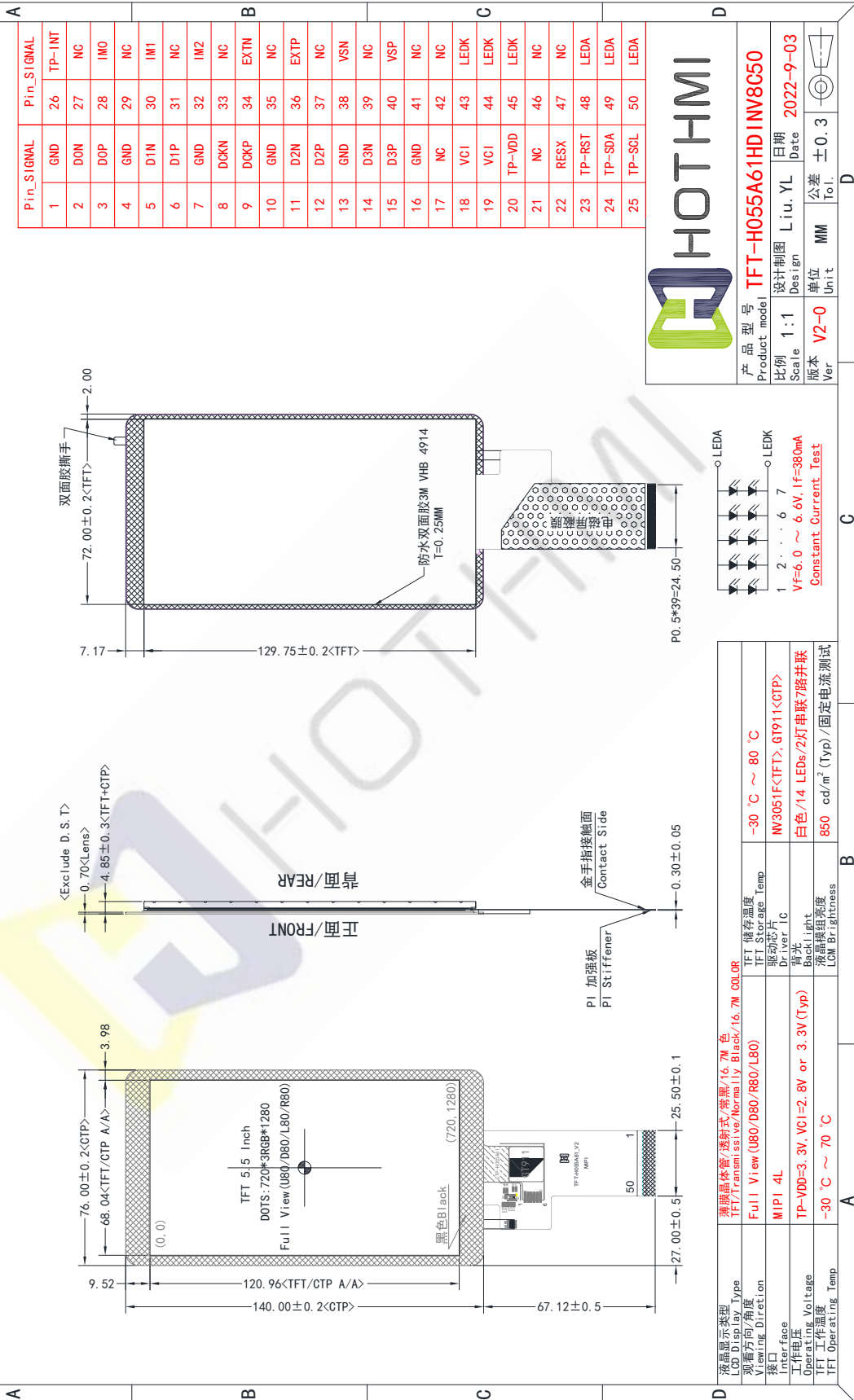

Pin	SIGNAL	Pin	SIGNAL
1	GND	26	TP-INT
2	DON	27	NC
3	DOP	28	IM0
4	GND	29	NC
5	D1N	30	IM1
6	D1P	31	NC
7	GND	32	IM2
8	D0KN	33	NC
9	D0KP	34	EXTN
10	GND	35	NC
11	D2N	36	EXTP
12	D2P	37	NC
13	GND	38	VSN
14	D3N	39	NC
15	D3P	40	VSP
16	GND	41	NC
17	NC	42	NC
18	VCI	43	LEDK
19	VCI	44	LEDK
20	TP-VDD	45	LEDK
21	NC	46	NC
22	RESX	47	NC
23	TP-RST	48	LEDA
24	TP-SDA	49	LEDA
25	TP-SCL	50	LEDA

HOTHMI

产品型号: **TFT-H055A61HD INV8C50**

Product model: **TFT-H055A61HD INV8C50**

比例 1:1 设计制图 Liu.YL 日期 2022-9-03

Scale 1:1 Design Liu.YL Date 2022-9-03

版本 V2-0 单位 MM 公差 ±0.3

Ver V2-0 Unit MM Tol. ±0.3

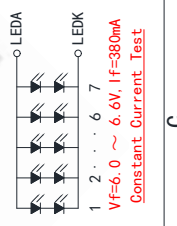

液晶显示类别 LCD Display Type	透射型窄视角/带黑/16.7M色 TFT/Transmissive/Narrow/Black/16.7M Color
视角方向/角度 Viewing Direction	Full View (U80/D80/R80/L80)
接口 Interface	MIP1 4L
工作电压 Operating Voltage	TP-VDD=3.3V, VCI=2.8V or 3.3V (Typ)
TFT 工作温度 TFT Operating Temp	-30 °C ~ 70 °C
存储温度 TFT Storage Temp	-30 °C ~ 80 °C
驱动芯片 Driver IC	NV3051F<TFT>, GT911<CTP>
背光 Backlight	白色/14 LEDs/2灯串联/路并联
液晶模组亮度 LCM Brightness	850 cd/m² (Typ)/固定电流测试

三、引脚说明 Pin Description

3.1 模组引脚说明 TFT Pin Description

引脚编号 Pin NO.	标号 Symbol	详细描述 Description
1	GND	电源地 Power supply ground
2	D0N	MIPI 负数据信号 (-) MIPI Negative data signal (-)
3	D0P	MIPI 正数据信号 (+) MIPI Positive data signal (+)
4	GND	电源地 Power supply ground
5	D1N	MIPI 负数据信号 (-) MIPI Negative data signal (-)
6	D1P	MIPI 正数据信号 (+) MIPI Positive data signal (+)
7	GND	电源地 Power supply ground
8	DCKN	MIPI 负时钟信号 (-) MIPI Negative clock signal (-)
9	DCKP	MIPI 正时钟信号 (+) MIPI Positive clock signal (+)
10	GND	电源地 Power supply ground
11	D2N	MIPI 负数据信号 (-) MIPI Negative data signal (-)
12	D2P	MIPI 正数据信号 (+) MIPI Positive data signal (+)
13	GND	电源地 Power supply ground
14	D3N	MIPI 负数据信号 (-) MIPI Negative data signal (-)
15	D3P	MIPI 正数据信号 (+) MIPI Positive data signal (+)
- 接下页 - - Continued on next page -		

引脚编号 Pin NO.	标号 Symbol	详细描述 Description
16	GND	电源地 Power supply ground
17	NC	不连接 Not connected
18 ~ 19	VCI	电源 Power supply
20	TP-VDD	电容触摸电源 CTP Power supply
21	NC	不连接 Not connected
22	RESX	重置复位引脚 Reset pin
23	TP-RST	电容触摸重置复位引脚 CTP Reset pin
24	TP-SDA	电容触摸I2C 数据信号 CTP I2C data signals
25	TP-SCL	电容触摸I2C 时钟信号 CTP I2C clock signal
26	TP-INT	电容触摸中断信号 CTP interrupt signal
27	NC	不连接 Not connected
28	IM0	配置通道的顺序和极性 Configure the order and polarity of the channels
29	NC	不连接 Not connected
30	IM1	配置通道的顺序和极性 Configure the order and polarity of the channels
31	NC	不连接 Not connected
32	IM2	配置通道的顺序和极性 Configure the order and polarity of the channels
33	NC	不连接 Not connected
- 接下页 - - Continued on next page -		

引脚编号 Pin NO.	标号 Symbol	详细描述 Description
34	EXTN	增压泵/补给泵电源IC输出, 产生VSN。不用时悬空 Booster/charge pump power IC output to generate VSN. Open when not in use
35	NC	不连接 Not connected
36	EXTP	增压泵/补给泵电源IC输出, 产生VSP。不用时悬空 Booster/charge pump power IC output to generate VSP. Open when not in use
37	NC	不连接 Not connected
38	VSN	模拟电源 (-5.0V至-6.0V), 推荐 -5.5V Analog power supply(-5.0V to -6.0V), Recommended-5.5V
39	NC	不连接 Not connected
40	VSP	模拟电源 (5.0V至6.0V), 推荐5.5V Analog power supply(5.0V to 6.0V), Recommended 5.5V
41 ~ 42	NC	不连接 Not connected
43 ~ 45	LEDK	LED阴极 LED cathode
46 ~ 47	NC	不连接 Not connected
48 ~ 50	LEDA	LED阳极 LED anode
- 结束 - - END -		

注释 Note:

下面的表格是 MIPI 4 通道设置的例子

The bottom table is an example for MIPI 4 lane setting

引脚序号 Pin No.			MIPI 通道的配置 Configuration of MIPI Lane				
IM2	IM1	IM0	D0P/N	D1P/N	DCKP/N	D2P/N	D3P/N
GND	GND	GND	D3P/N	D2P/N	DCKP/N	D1P/N	D0P/N
GND	GND	VCI	D3N/P	D2N/P	DCKN/P	D1N/P	D0N/P
GND	VCI	GND	D0P/N	D1P/N	DCKP/N	D2P/N	D3P/N
GND	VCI	VCI	D0N/P	D1N/P	DCKN/P	D2N/P	D3N/P
VCI	GND	GND	D3P/N	D0P/N	DCKP/N	D1P/N	D2P/N
VCI	GND	VCI	D3N/P	D0N/P	DCKN/P	D1N/P	D2N/P
VCI	VCI	GND	D2P/N	D1P/N	DCKP/N	D0P/N	D3P/N
VCI	VCI	VCI	D2N/P	D1N/P	DCKN/P	D0N/P	D3N/P

3.2 接线说明 Wiring instructions

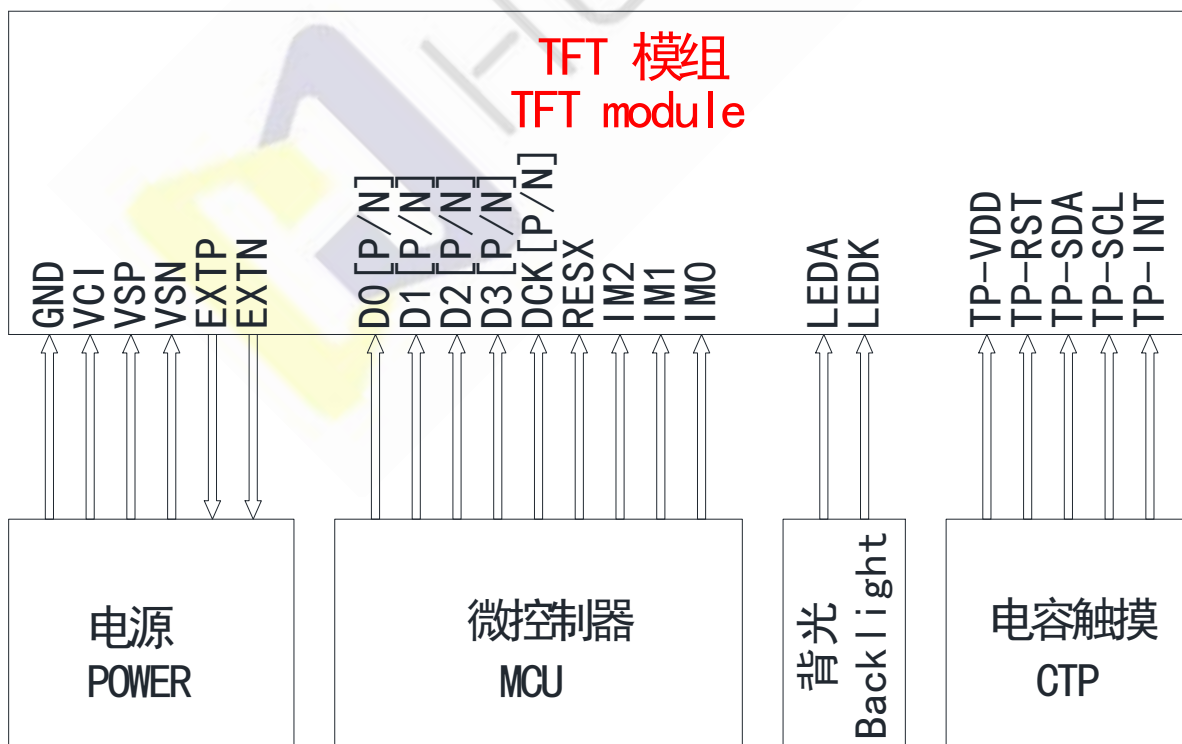

四、电气特性 Electrical Characteristics

4-1 TFT 模组工作条件 TFT LCD Module Operating Conditions

项目 Item	标号 Symbol	条件 Condition	最小值 Min	典型值 Type	最大值 Max	单位 Unit
数字电源 Digital Power	VCI	-	-0.3	-	4.0	伏 V
接口工作电压 IO Supply Voltage	IOVCC	-	-0.3	-	4.0	伏 V
输入电压范围 Input Voltage Range	VIN	-	-0.3	-	IOVCC +0.3	伏 V

注释 Note:

1. 超过上面列出的极限值可能会导致驱动 IC 永久损坏。这些值仅用于测试。IC 应在芯片特性条件下正常运行。如果不满足这些条件，IC 操作可能会出错，可靠性可能会下降。

That the exceeds the Limiting Value listed above it may cause the driver IC permanent damage. These values are for test only. IC should be operated under the Chip Characteristic conditions for normal operation. If these conditions are not met, IC operation may be error and the reliability may be deteriorated.

2. 参数在工作温度范围内有效，除非另有说明。除非另有说明，所有电压均相对于 GND。

Parameters are valid over operating temperature range unless otherwise specified. All voltages are with respect to GND unless otherwise noted.

3. 确保 IOVCC、VCI 的电压电平始终符合正确的关系： $2.6V \leq IOVCC \leq VCC \leq 3.6V$ 。

Insure the voltage levels of IOVCC, VCI, always matches the correct relation:
 $2.6V \leq IOVCC \leq VCC \leq 3.6V$.

4. VIN 应小于或等于 3.6V。 ($VIN \leq 3.6V$)。

VIN should be less than or equal to 3.6V. ($VIN \leq 3.6V$).

5. 面板显示质量取决于面板负载，在低温/高温下可能有不同的性能。

Panel display quality depends on panel loading, and it may have the different performance at low/high temperature.

4-2 TFT 面板工作条件 TFT Panel Operating Conditions

项目 Item	标号 Symbol	条件 Condition	最小值 Min	典型值 Type	最大值 Max	单位 Unit
数字电源 Digital Power	VCI	-	2.6	2.8	3.6	伏 V
接口工作电压 IO Supply Voltage	IOVCC	-	2.6	2.8	3.6	伏 V
输入电压范围 Input Voltage Range	VIN	-	2.6	2.8	3.6	伏 V
待机电流 Standby Current	Isc	No Load@ FR=60Hz	-	-	-	微安 uA
工作电流 Operation Current	Ioc		-	-	-	毫安 mA

4-3 背光工作条件 LED back light specification

项目 Item	标号 Symbol	条件 Condition	最小值 Min	典型值 Type	最大值 Max	单位 Unit
工作电压 Forward voltage	VF	-	6.0	-	6.6	伏 V
工作电流 Forward current	IF		-	380	-	毫安 mA
亮度 (带 LCD) Luminance (With LCD)	Lv	Without TP	-	1000	-	坎德拉/平方米 cd/m ²
		With TP	-	850	-	
LED 寿命 LED life time	Hr	Ta=25±3 °C	20,000	30,000	-	小时 Hour

注释 Note:

1. LED 寿命 (Hr) 定义为在 Ta=25±3 °C, 上表所示的典型电压电流值条件下持续工作直至亮度低于 50% 的时间。

LED life time (Hr) can be defined as the time in which it continues to operate under the condition: Ta=25±3 °C, typical IL value indicated in the above table until the brightness becomes less than 50%.

2. 以上结果是按 MTBF 计算方式预估判定的 LED 失效时间, 实际测试 LED 在 Ta=25±3 °C 点亮 5000H, 亮度衰减 8%.

The above results are estimated and judged by the MTBF calculation method of the LED failure time. The actual test LED is lit for 5000H at Ta=25±3 °C, and the brightness decays by 8%.

五、液晶光学规格 TFT OPTICAL SPECIFICATION

5.1 概述 Overview

光学规格的测试应在暗室（环境亮度 1lux，温度=25 2°C）中使用亮度计系统（测角仪系统和TOPCON BM-5）设备进行测量，测试单元应位于大约在 θ 和 Φ 等于 0 的视角下，距 LCD 表面 50cm 的距离。显示面上测量点的中心应保持固定。测量前背光应工作 30 分钟。

The test of Optical specifications shall be measured in a dark room (ambient luminance 1lux and temperature = 25 2°C) with the equipment of Luminance meter system (Goniometer system and TOPCON BM-5) and test unit shall be located at an approximate distance 50cm from the LCD surface at a viewing angle of θ and Φ equal to 0 . The center of the measuring spot on the Display surface shall stay fixed. The backlight should be operating for 30 minutes prior to measurement.

5.2 光学规格 Optical Specifications

参数 Parameter		标号 Symbol	条件 Condition	最小值 Min.	典型值 Typ.	最大值 Max.	单位 Unit	备注 Remark
视角范围 Viewing Angle Range	水平 Horizontal	⊕左/L	CR>10	-	80	-	Deg.	Note 1
		⊕右/R		-	80	-	Deg.	
	垂直 Vertical	⊕上/U		-	80	-	Deg.	
		⊕下/D		-	80	-	Deg.	
对比度 Contrast ratio		CR	⊕ = 0°	800	1000	-	-	Note2
色域 Color Gamut		CG	CIE1931	-	68	-	%	
白色色度 White Chromaticity		Wx	⊕ = 0°	-0.03	0.301	+0.03	-	Note4 (Based on C Light)
		Wy			0.320		-	
色彩还原 Reproduction of color	红 Red	Rx			0.647		-	
		Ry			0.317		-	
	绿 Green	Gx			0.258		-	
		Gy			0.566		-	
蓝 Blue	Bx	0.140	-					
	By	0.088	-					
响应时间（上升 + 下降） Response Time (Rising + Falling)		Tr+Tf	⊕ = 0° Ta= 25°C	-	30	35	ms	Note5

注释 Note:

1. 视角是对比度大于10的角度。视角确定为相对于光轴的水平或3、9点钟方向和垂直或6、12点钟方向 垂直于 LCD 表面（见图 1）。

Viewing angle is the angle at which the contrast ratio is greater than 10. The viewing angles are determined for the horizontal or 3, 9 o' clock direction and the vertical or 6, 12 o' clock direction with respect to the optical axis which is normal to the LCD surface (see FIGURE 1).

2. 对比度测量应在 $\theta = 0$ 的视角和 LCD 表面的中心进行。亮度测量时，视场中的所有像素首先设置为白色，然后设置为暗（黑色）状态。（参见图 1）亮度对比度（CR）是通过数学定义的。

Contrast measurements shall be made at viewing angle of $\Theta = 0$ and at the center of the LCD surface. Luminance shall be measured with all pixels in the view field set first to white, then to the dark (black) state. (see FIGUR 1) Luminance Contrast Ratio (CR) is defined mathematically.

$$CR = \frac{\text{Luminance when displaying a white raster}}{\text{Luminance when displaying a black raster}}$$

3. 透射率是没有 APF 和没有 CG 的值。

Transmittance is the Value without APF and without CG.

4. 上表中规定的色度坐标应由所有像素首先测量的光谱数据计算为红色、绿色、蓝色和白色。测量应在面板的中心进行。

The color chromaticity coordinates specified in the above table shall be calculated from the spectral data measured with all pixels first in red, green, blue and white. Measurements shall be made at the center of the panel.

5. 电光响应时间测量应如图 2 所示，通过打开和关闭“数据”输入信号来进行。亮度从 10%变化到90%所需的时间是 T_r ，90%到10%是 T_f 。

The electro-optical response time measurements shall be made as FIGURE 2 by switching the “data” input signal ON and OFF. The times needed for the luminance to change from 10% to 90% is T_r , and 90% to 10% is T_f .

Figure1 Measurement Set Up



图 1



图 2

六、交流特性 AC characteristic

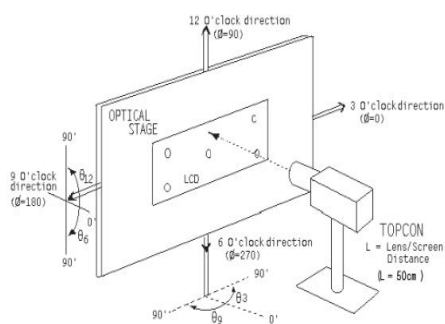
6.1. 时序 Timing

1) 高速模式 High Speed Mode

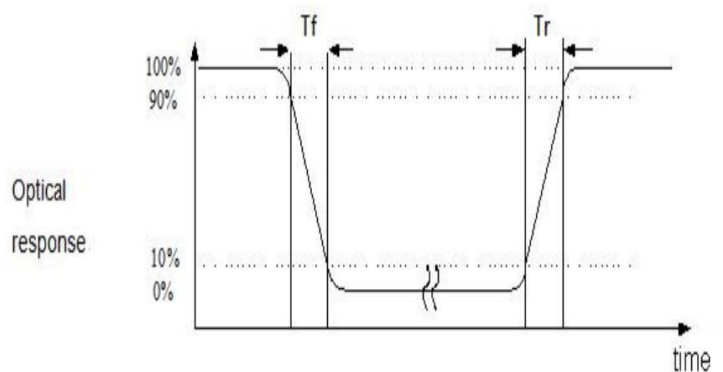
Parameter	Symbol	Parameter	Specification			Unit
			MIN	TYP	MAX	
High Speed Mode						
DSI-CLK+/-	$2XU_{inst}$	Double UI instantaneous	2.22	-	25	ns
DSI-CLK+/-	U_{INSTA}, U_{INSTB}	UI instantaneous Halfs	1.11	-	12.5	ns
DSI-Dn+/-	T_{ds}	Data to clock setup time	0.15	-	-	UI
DSI-Dn+/-	T_{dh}	Data to clock hold time	0.15	-	-	UI
DSI-CLK+/-	T_{drclk}	Differential rise time for clock	150	-	0.3UI	ps
DSI-Dn+/-	T_{drdata}	Differential rise time for data	150	-	0.3UI	ps
DSI-CLK+/-	T_{dfclk}	Differential fall time for clock	150	-	0.3UI	ps
DSI-Dn+/-	T_{dfdata}	Differential fall time for data	150	-	0.3UI	ps

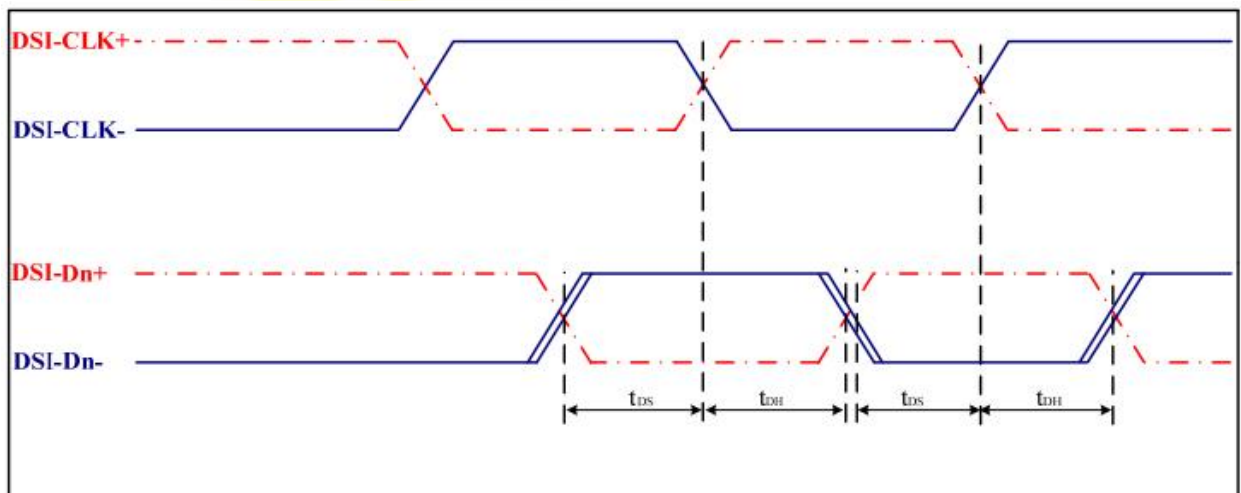
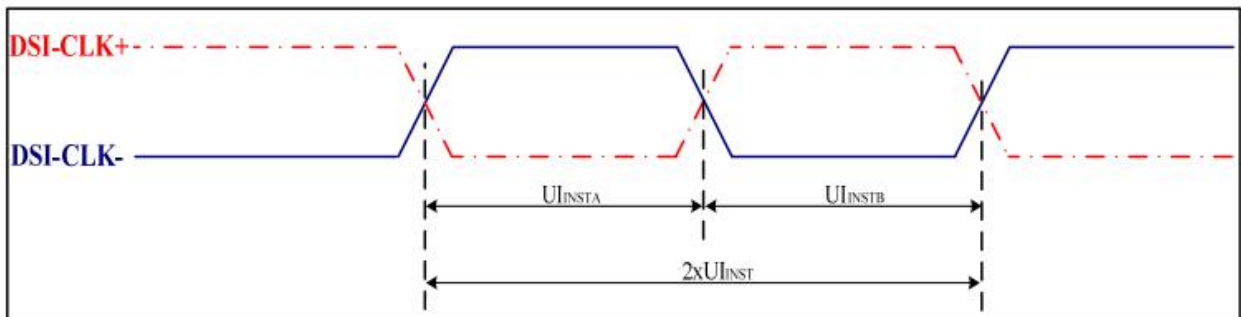

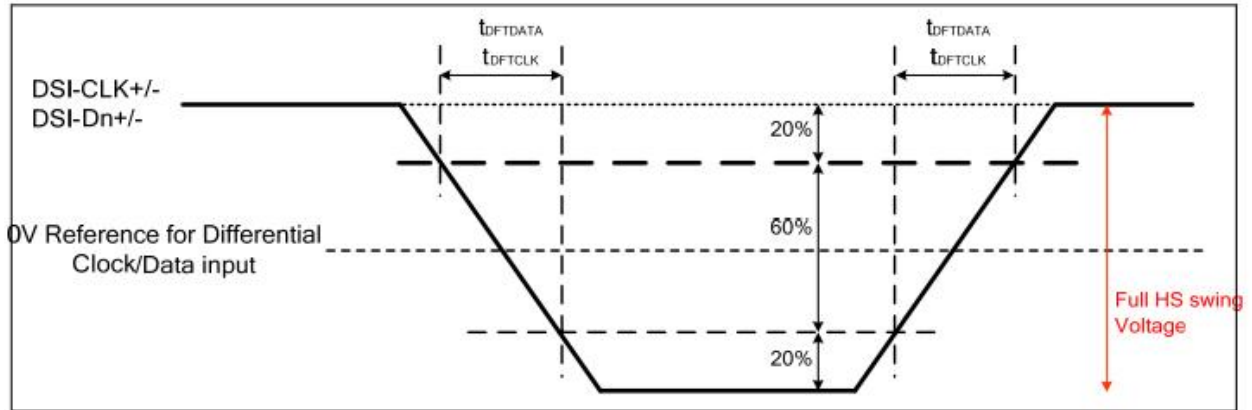

2) 低功耗模式 Low power mode

Parameter	Symbol	Parameter	Specification			Unit
			MIN	TYP	MAX	
Low Power Mode						
DSI-D0+/-	TLPXM	Length of LP-00, LP-01, LP-10 or LP-11 periods MPU Display Module	50	-	-	ns
DSI- D0+/-	TLPXD	Length of LP-00, LP-01, LP-10 or LP-11 periods Display Modulen MPU	58	-	-	ns
DSI- D0+/-	TTA-SURED	Time-out before the MPU start driving	TLPXD	-	2XTLPXD	ns
DSI- D0+/-	TTA-GETD	Time to drive LP-00 by display module	5XTLPXD	-	-	ns
DSI- D0+/-	TTA-GOD	Time to drive LP-00 after turnaround request – MPU	4XTLPXD	-	-	ns
DSI- D0+/-	Ratio TLPX	Ratio of TLPXM / TLPXD between MCU and display module	2/3	-	3/2	

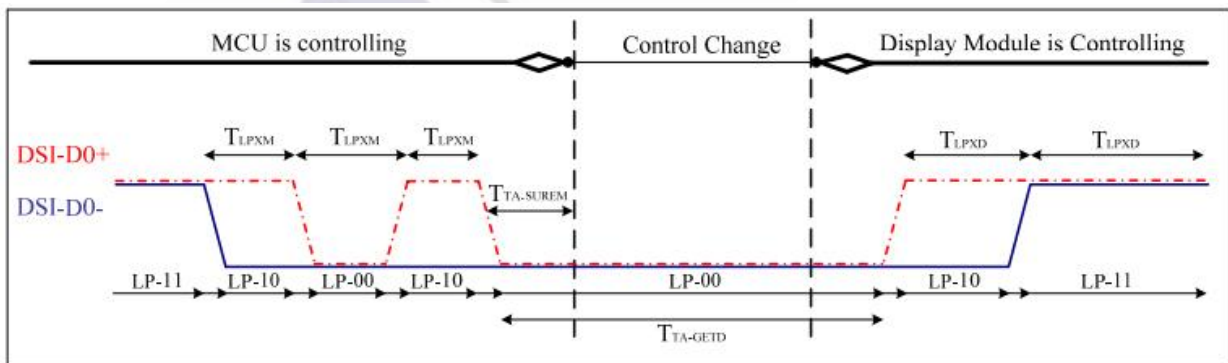

Figure: BTA from the MCU to the Display Module

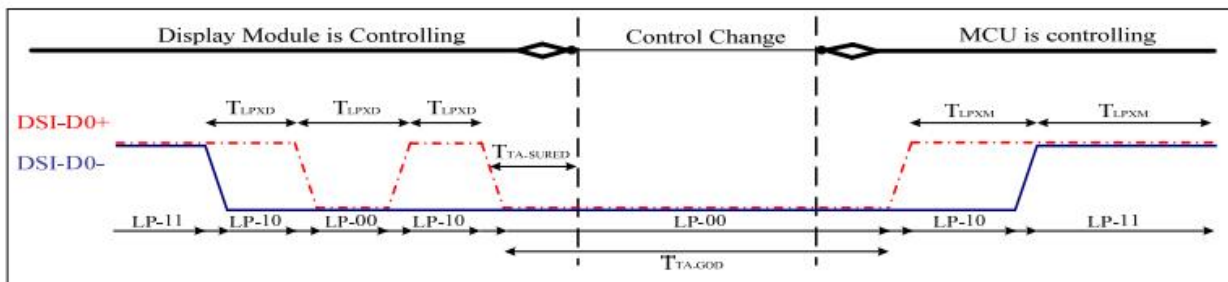

Figure: BTA from the Display Module to the MCU

3) 突发模式 Bursts Mode

Parameter	Symbol	Parameter	Specification			Unit
			MIN	TYP	MAX	
High Speed Data Transmission Bursts						
DSI-Dn+/-	TLPX	Length of any low-power state period	50	-	-	ns
DSI- Dn+/-	THS- PREPARE	Time to drive LP-00 to prepare for HS transmission	40ns+4UI	-	85ns+6UI	ns
DSI- Dn+/-	THS- PREPARE+THS- ZERO	THS-PREPARE+time to drive HS-0 before the sync sequence	145ns+10UI	-	-	ns
DSI- Dn+/-	TD-TERM- EN	Time to enable Data Lane receiver line termination measured from when Dn crosses VIL(max)	Time for Dn to reach VTERM-EN	-	35ns+4UI	ns
DSI- Dn+/-	THS-SKIP	Time-out at RX to ignore transition period of EoT	40	-	55ns+4UI	ns
DSI- Dn+/-	THS-TRAIL	Time to drive flipped differential state after last payload data bit of a HS transmission burst	max (8UI, 60ns+4UI)	-	-	ns
DSI- Dn+/-	THS-EXIT	Time to drive LP-11 after HS burst	100	-	-	ns
DSI- Dn+/-	TeoT	Time from start of THS-TRAIL period to start of LP-11 state	-	-	105ns+12UI	ns

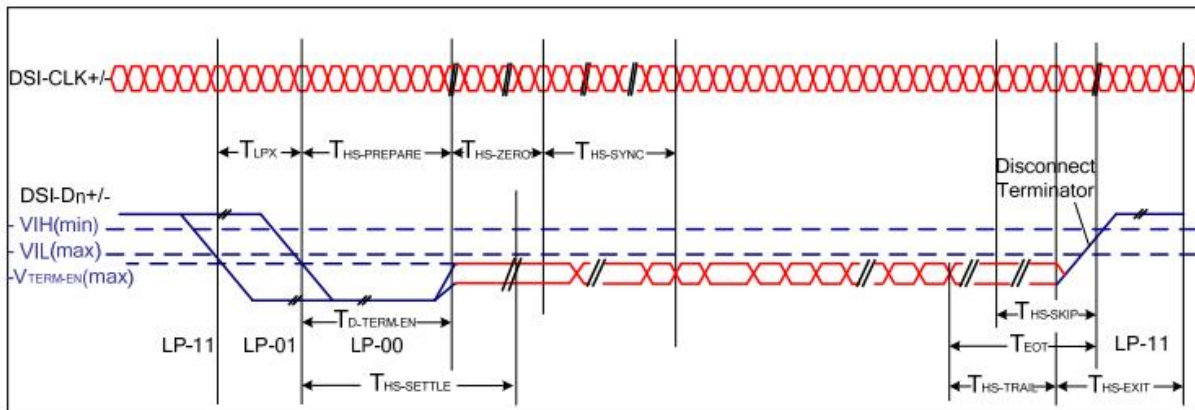

Figure: High Speed Data Transmission Bursts

4) 重置时序 Reset Timing

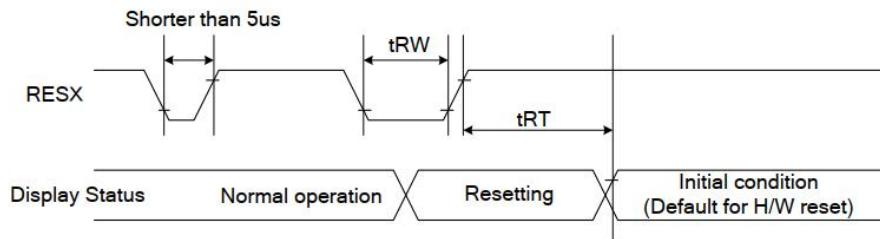

Figure 113: Reset Timing

Table 47: Reset Timing

Signal	Symbol	Parameter	Min	Max	Unit
RESX	tRW	Reset pulse duration	10		uS
	tRT	Reset cancel		5 (note 1,5) 120 (note 1,6,7)	mS

Notes:

1. The reset cancel also includes required time for loading ID bytes, VCOM setting and other settings from EEPROM to registers. This loading is done every time when there is H/W reset cancel time (tRT) within 5 ms after a rising edge of RESX.
2. Spike due to an electrostatic discharge on RESX line does not cause irregular system reset according to the Table 48.

Table 48: Reset Descript

RESX Pulse	Action
Shorter than 5us	Reset Rejected
Longer than 10us	Reset
Between 5us and 10us	Reset starts

3. During the Resetting period, the display will be blanked (The display enters the blanking sequence, which maximum time is 120 ms, when Reset Starts in the Sleep Out mode. The display remains the blank state in the Sleep In mode.) and then return to Default condition for Hardware Reset.
4. Spike Rejection can also be applied during a valid reset pulse, as shown below:

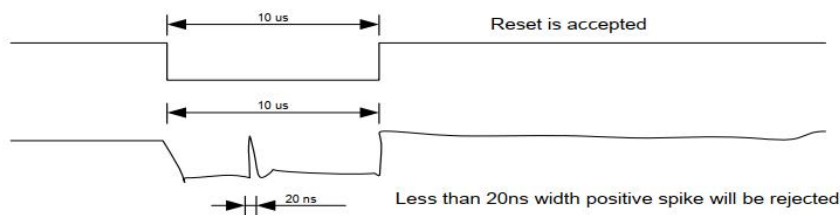

Figure 114: Positive Noise Pulse during Reset Low

5. When Reset applied during Sleep In Mode.
6. When Reset applied during Sleep Out Mode.
7. It is necessary to wait 5msec after releasing RESX before sending commands. Also Sleep Out command cannot be sent for 120msec.

5) 开机上电/掉电顺序 Power On/Off Sequence

IOVCC 和 VDD 可以按任何顺序应用。

IOVCC and VDD can be applied in any order.

VDD 和 IOVCC 可以按任何顺序断电。

VDD and IOVCC can be power down in any order.

在关机期间, 如果 LCD 处于睡眠模式, VDD 和 IOVCC 必须在 RESX 释放后至少 120 毫秒内断电。

During power off, if LCD is in the Sleep Out mode, VDD and IOVCC must be powered down minimum 120msec after RESX has been released.

在断电期间, 如果 LCD 处于睡眠模式, VDDI 或 VDD 可以在 RESX 释放后至少 0 毫秒内断电。

During power off, if LCD is in the Sleep In mode, VDDI or VDD can be powered down minimum 0msec after RESX has been released.

CSX 可以在任何时间应用, 也可以永久接地。RESX 比 CSX 有优先权。

CSX can be applied at any timing or can be permanently grounded. RESX has priority over CSX.

注 1: 如果不符合电源顺序, 将不会对显示模块造成损害。

Note 1: There will be no damage to the display module if the power sequences are not met.

注 2: 在通电/断电序列期间, 显示面板上不会出现异常的可见效果。

Note 2: There will be no abnormal visible effects on the display panel during the Power On/Off Sequences.

注 3: 在开机顺序结束后到接收睡眠结束命令前, 显示屏上不会出现异常可见的效果。在接收 "睡眠" 命令和 "关机" 序列之间也是如此。

Note 3: There will be no abnormal visible effects on the display between end of Power On Sequence and before receiving Sleep Out command. Also between receiving Sleep In command and Power Off Sequence.

注 4: 如果 RESX 线在开机顺序中没有被主机保持稳定, 如下面的顺序所定义, 那么在主机开机顺序完成后, 有必要应用硬件复位 (RESX) 以确保正确操作。否则, 功能将无法保证。

Note 4: If RESX line is not held stable by host during Power On Sequence as defined in the sequence below, then it will be necessary to apply a Hardware Reset (RESX) after Host Power On Sequence is complete to ensure correct operation. Otherwise function is

not guaranteed.

电源开/关顺序如下图所示 The power on/off sequence is illustrated below

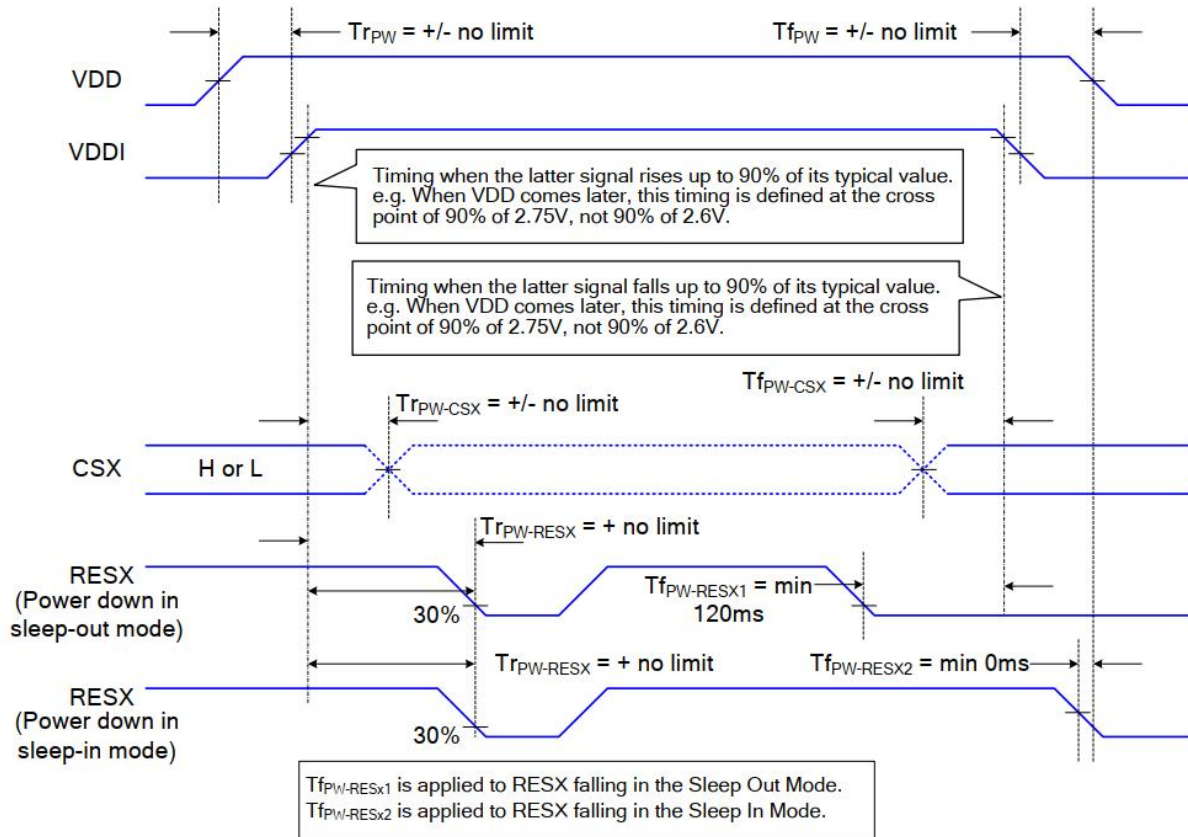

不受控制的断电是指在没有受控制的断电顺序的情况下取出电池。它既不会损坏模块，也不会损坏主机接口。

The uncontrolled power-off means a situation which removed a battery without the controlled power off sequence. It will neither damage the module or the host interface.

如果发生不受控制的断电，显示屏将变成空白，没有任何可见的影响。显示屏上没有任何可见的影响（空白显示），并保持空白，直到“通电顺序”将其恢复。

If uncontrolled power-off happened, the display will go blank and there will not any visible effect on the display (blank display) and remains blank until “Power On Sequence” powers it up

七、可靠性测试 RELIABILITY TEST

7-1 温度和湿度 Temperature and Humidity

测试项目 TEST ITEMS	条件 CONDITIONS	注释 NOTE
高温储存 High Temperature Storage	Ta=+80 o C, 120hrs	
低温储存 Low Temperature Storage	Ta=-30 o C, 120hrs	
高温运行试验 High Temperature Operation	Ta=+70 o C, 120hrs	
低温运行试验 Low Temperature Operation	Ta=-30 o C, 120hrs	
高温高湿（运行测试） High Temperature and High Humidity (Operating)	Ta=+60 o C, 90%RH, 120hrs	

注释 Note:

1. 液晶驱动电压。由于液晶材料的特性，该电压随环境温度而变化。

Liquid Crystal driving voltage. Due to the characteristics of LC Material, this voltage varies with environmental temperature.

2. 温度和相对湿度范围如下图所示。湿球温度最高应为39℃。并且没有冷凝水。

Temperature and relative humidity range are shown in the figure below. Wet bulb temperature should be 39 °C max. and no condensation of water.

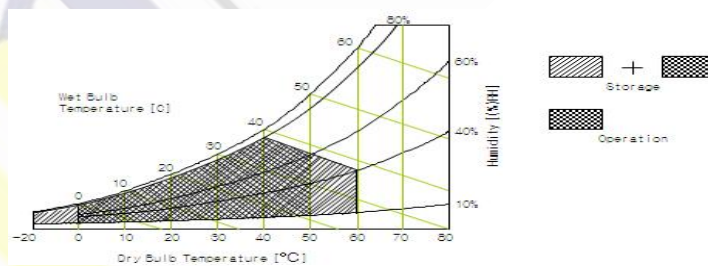

3. 产品经可靠性测试后，仅保证功能正常，无任何致命缺陷（不显示、线路缺陷、显示异常等）。

After the reliability test, the product only guarantee function normally without any fatal defect(non-display, line defect, abnormal display etc).

4. 所有显示判断均在面板温度恢复到室温后进行

All judgments of display are performed after temp of panel returns to room temperature

5. Ta: 环境温度

Ta: Ambient temperature

7-2 冲击和振动 Shock and Vibration

测试项目 TEST ITEMS	条件 CONDITIONS
包装冲击(非操作) Packing Shock (Non-Operation)	<ul style="list-style-type: none"> ● Shock level:980m/s² ● Waveform:1/2 Sine wave,6msec ● ±X, ±Y ±Z, each axis 1 times
包装振动(非操作) Packing Vibration (Non-Operation)	<ul style="list-style-type: none"> ● Frequency range:8-33.3HZ ● Stoke:1.0mm ● Sweep: 10Hz-50Hz ● x, y, z 2 hours for each direction

7-3 静电放电测试 Electrostatic Discharge

测试项目 TEST ITEMS	条件 CONDITIONS
ESD (Non-operation)	150pF, 330 Ω , Contact ±4KV, Air : ±8KV. Note 1
	200pF, 0 Ω , ±200V Contact test. Note 2

测量点 Measure Point:

1. LCD玻璃和金属边框
LCD glass and metal bezel
2. 连接器引脚
IF connector pins

八、处理和注意事项 HANDLING & CAUTIONS

8-1 操作注意事项 Caution For Operation

◆由于液晶模组是玻璃材质，请勿对其施加强烈的机械冲击或静载荷。请小心搬运，因为冲击、振动和粗心的搬运可能会严重影响产品。如果从高处坠落或受到强烈冲击，玻璃可能碎了。

Since the LCM is made of glass, do not apply strong mechanical impact or static load onto it. Handling with care since shock, vibration, and careless handling may seriously affect the product. If it falls from a high place or receives a strong shock, the glass maybe broken.

◆在规定的电压限制内驱动 LCM 是必不可少的，因为高于限制的电压会导致 LCM 的寿命缩短。由直流引起的电化学反应会导致 LCM 出现不良劣化，因此应避免使用直流驱动。

It is indispensable to drive the LCM within the specified voltage limit since the higher voltage than the limit causes LCM's life shorter. An electro-chemical reaction due to DC causes undesirable deterioration of the LCM so that the use of DC drive should avoid.

◆请勿在电源开启时将 LCM 连接到系统或从系统断开连接。

Do not connect or disconnect the LCM to or from the system when power is on.

◆切勿在高温高湿的异常条件下使用 LCM。

Never use the LCM under abnormal conditions of high temperature and high humidity.

◆当暴露于剧烈的温度波动（热到冷或冷到热）时，LCM可能会受到影响；具体来说，从冷到热的剧烈温度波动会在 LCM 表面产生露水，这可能会影响 LCM 上偏振片的运行。

When expose to drastic fluctuation of temperature (hot to cold or cold to hot), the LCM may be affected; specifically, drastic temperature fluctuation from cold to hot, produces dew on the LCM's surface which may affect the operation of the polarizer on the LCM.

◆在低于工作温度范围的温度下，响应时间将极度延迟，另一方面，在高于其工作范围的温度下，LCM 可能会变黑。然而，这些现象并不意味着 LCM 出现故障或故障。一旦温度恢复到正常运行的推荐温度范围，LCM 将恢复正常运行。

Response time will be extremely delay at lower temperature than the operating temperature range and on the other hand LCM may turn black at temperature above its operational range. However those phenomenon do not mean malfunction or out of order with the LCM. The LCM will revert to normal operation once the temperature returns to the recommended temperature range for normal operation.

◆为防止LCD产生图像残留，在使用常黑面板时不要长时间显示固定图案。如果LCD需要显示固定图案，建议时间少于 2 分钟或者更短的时间内刷新显示内容一次或多次。强烈建议使用黑色图像或移动图像作为屏幕保护程序。

In order to prevent the LCD from producing image retention, do not display a fixed pattern for a long time when using a normally black panel. If the LCD needs to display a fixed pattern, it is recommended to refresh the display one or more times in less

than 2 minutes or less. It is strongly recommended to use a black image or moving image as a screen saver.

◆强烈的光照会导致 LCD 偏光片和彩色滤光片退化。不准在强光或高温高湿下长期存放或直接运行。

Strong sunlight can cause LCD polarizers and color filters to degrade. Long-term storage or direct operation under strong light or high temperature and humidity is not allowed.

8-2 防静电措施 Caution Against Static Charge

◆LCM 使用 C-MOS LSI 驱动器，因此建议客户将任何未使用的输入端连接到 Vdd 或 Vss，上电前不要输入任何信号，并将您的身体、工作/装配区、装配设备接地 防止静电。

The LCM use C-MOS LSI drivers, so customers are recommended that any unused input terminal would be connected to Vdd or Vss, do not input any signals before power is turn on, and ground you body, work/assembly area, assembly equipments to protect against static electricity.

◆缓慢去除保护膜，保持去除方向与面板表面不垂直约 30 度，如有可能，在离子风机等 ESD 控制装置下，工作室湿度应保持在 50%RH 以上，以减少静电风险

Remove the protective film slowly, keeping the removing direction approximate 30-degree not vertical from panel surface, if possible, under ESD control device like ion blower, and the humidity of working room should be kept over 50%RH to reduce the risk of static charge.

◆避免使用合成纤维制成的工作服。我们推荐棉质衣服或其他经过导电处理的纤维。

Avoid the use work clothing made of synthetic fibers. We recommend cotton clothing or other conductivity-treated fibers.

◆在处理 LCM 时，请戴上不带电材料的手套。对地导电手腕和对地导电鞋是必需的

In handling the LCM, wear non-charged material gloves. And the conducting wrist to the earth and the conducting shoes to the earth are necessary

九、初始化代码 Initialization code

```

Void Panel_initial_code(void)
{
//TFT分辨率: 720 x 1280
//测试接口: MIPI
//测试板主控:
//Power:VCI=2.8V, IOVCC=1.8V

#define HSPW 2
#define HBPD 30
#define HFPD 24
#define HDP 720

#define VSPW 2
#define VBPD 5
#define VFDP 16
#define VDP 1280

//External system porch setting:
//Line Time: uS
//Frame Rate: 60 Hz
//Pixel Clk: MHz
//=====上电复位操作=====//
LCD_RESET=1;
Delays(1); //Delay 1ms
LCD_RESET=0;
Delays(10); //Delay 10ms
LCD_RESET=1;
Delays(120); //Delay 120ms
//=====//
Wrt_Reg_3052(0xFF, 0x30);
Wrt_Reg_3052(0xFF, 0x52);
Wrt_Reg_3052(0xFF, 0x01);
Wrt_Reg_3052(0xE3, 0x00);
Wrt_Reg_3052(0x25, 0x0A);
Wrt_Reg_3052(0x28, 0x5F);
Wrt_Reg_3052(0x29, 0xc4);
Wrt_Reg_3052(0x37, 0x9c);
Wrt_Reg_3052(0x38, 0xA7);

```

Wrt_Reg_3052(0x39, 0x53) ; //VCOM

Wrt_Reg_3052(0x44, 0x00) ;

Wrt_Reg_3052(0x49, 0x7C) ;

Wrt_Reg_3052(0x59, 0xfe) ;

Wrt_Reg_3052(0x5C, 0x00) ;

Wrt_Reg_3052(0x80, 0x20) ; //add

Wrt_Reg_3052(0x91, 0x67) ; //add

Wrt_Reg_3052(0x92, 0x67) ; //add

Wrt_Reg_3052(0xA0, 0x55) ;

Wrt_Reg_3052(0xA1, 0x50) ;

//Wrt_Reg_3052(0xA3, 0x58) ;

Wrt_Reg_3052(0xA4, 0x9C) ;

Wrt_Reg_3052(0xA7, 0x02) ;

Wrt_Reg_3052(0xA8, 0x01) ;

Wrt_Reg_3052(0xA9, 0x21) ;

Wrt_Reg_3052(0xAA, 0xFC) ;

Wrt_Reg_3052(0xAB, 0x28) ;

Wrt_Reg_3052(0xAC, 0x06) ;

Wrt_Reg_3052(0xAD, 0x06) ;

Wrt_Reg_3052(0xAE, 0x06) ;

Wrt_Reg_3052(0xAF, 0x03) ;

Wrt_Reg_3052(0xB0, 0x08) ;

Wrt_Reg_3052(0xB1, 0x26) ;

Wrt_Reg_3052(0xB2, 0x28) ;

Wrt_Reg_3052(0xB3, 0x28) ;

Wrt_Reg_3052(0xB4, 0x03) ;

Wrt_Reg_3052(0xB5, 0x08) ;

Wrt_Reg_3052(0xB6, 0x26) ;

Wrt_Reg_3052(0xB7, 0x08) ;

Wrt_Reg_3052(0xB8, 0x26) ;

Wrt_Reg_3052(0xFF, 0x30) ;

Wrt_Reg_3052(0xFF, 0x52) ;

Wrt_Reg_3052(0xFF, 0x02) ;

Wrt_Reg_3052(0xB0, 0x03) ;

Wrt_Reg_3052(0xB1, 0x06) ;

Wrt_Reg_3052(0xB2, 0x04) ;

Wrt_Reg_3052(0xB3, 0x26);
Wrt_Reg_3052(0xB4, 0x2D);
Wrt_Reg_3052(0xB5, 0x2D);
Wrt_Reg_3052(0xB6, 0x09);
Wrt_Reg_3052(0xB7, 0x2D);
Wrt_Reg_3052(0xB8, 0x08);
Wrt_Reg_3052(0xB9, 0x02);
Wrt_Reg_3052(0xBA, 0x10);
Wrt_Reg_3052(0xBB, 0x0F);
Wrt_Reg_3052(0xBC, 0x10);
Wrt_Reg_3052(0xBD, 0x14);
Wrt_Reg_3052(0xBE, 0x19);
Wrt_Reg_3052(0xBF, 0x11);
Wrt_Reg_3052(0xC0, 0x18);
Wrt_Reg_3052(0xC1, 0x08);
Wrt_Reg_3052(0xD0, 0x07);
Wrt_Reg_3052(0xD1, 0x0C);
Wrt_Reg_3052(0xD2, 0x06);
Wrt_Reg_3052(0xD3, 0x2C);
Wrt_Reg_3052(0xD4, 0x2D);
Wrt_Reg_3052(0xD5, 0x33);
Wrt_Reg_3052(0xD6, 0x0F);
Wrt_Reg_3052(0xD7, 0x32);
Wrt_Reg_3052(0xD8, 0x0B);
Wrt_Reg_3052(0xD9, 0x02);
Wrt_Reg_3052(0xDA, 0x10);
Wrt_Reg_3052(0xDB, 0x0F);
Wrt_Reg_3052(0xDC, 0x11);
Wrt_Reg_3052(0xDD, 0x13);
Wrt_Reg_3052(0xDE, 0x19);
Wrt_Reg_3052(0xDF, 0x11);
Wrt_Reg_3052(0xE0, 0x19);
Wrt_Reg_3052(0xE1, 0x07);

Wrt_Reg_3052(0xff, 0x30);
Wrt_Reg_3052(0xff, 0x52);
Wrt_Reg_3052(0xff, 0x03);
Wrt_Reg_3052(0x07, 0x03);
Wrt_Reg_3052(0x08, 0x83);
Wrt_Reg_3052(0x09, 0x84);

Wrt_Reg_3052(0x25, 0x32);
Wrt_Reg_3052(0x27, 0x03);
Wrt_Reg_3052(0x2a, 0x02);
Wrt_Reg_3052(0x2b, 0x01);
Wrt_Reg_3052(0x34, 0x51);
Wrt_Reg_3052(0x35, 0x76);
Wrt_Reg_3052(0x36, 0x08);
Wrt_Reg_3052(0x37, 0x13);
Wrt_Reg_3052(0x40, 0x82);
Wrt_Reg_3052(0x41, 0x83);
Wrt_Reg_3052(0x42, 0x00);
Wrt_Reg_3052(0x43, 0x81);

Wrt_Reg_3052(0x45, 0x01);
Wrt_Reg_3052(0x46, 0x00);
Wrt_Reg_3052(0x48, 0x03);
Wrt_Reg_3052(0x49, 0x02);

Wrt_Reg_3052(0x50, 0x02);
Wrt_Reg_3052(0x51, 0x01);
Wrt_Reg_3052(0x52, 0x04);
Wrt_Reg_3052(0x53, 0x03);

Wrt_Reg_3052(0x55, 0x05);
Wrt_Reg_3052(0x56, 0x04);
Wrt_Reg_3052(0x58, 0x07);
Wrt_Reg_3052(0x59, 0x06);

Wrt_Reg_3052(0x80, 0x0e);
Wrt_Reg_3052(0x81, 0x0f);
Wrt_Reg_3052(0x82, 0x0e);
Wrt_Reg_3052(0x83, 0x0f);
Wrt_Reg_3052(0x84, 0x04);
Wrt_Reg_3052(0x85, 0x05);
Wrt_Reg_3052(0x86, 0x06);
Wrt_Reg_3052(0x87, 0x07);
Wrt_Reg_3052(0x88, 0x00);
Wrt_Reg_3052(0x8f, 0x02);

Wrt_Reg_3052(0x96, 0x0e);

```

Wrt_Reg_3052(0x97, 0x0f) ;
Wrt_Reg_3052(0x98, 0x0e) ;
Wrt_Reg_3052(0x99, 0x0f) ;
Wrt_Reg_3052(0x9a, 0x04) ;
Wrt_Reg_3052(0x9b, 0x05) ;
Wrt_Reg_3052(0x9c, 0x06) ;
Wrt_Reg_3052(0x9d, 0x07) ;
Wrt_Reg_3052(0x9e, 0x00) ;
Wrt_Reg_3052(0xa5, 0x02) ;
Wrt_Reg_3052(0xE0, 0x02) ;
Wrt_Reg_3052(0xE1, 0x5A) ;

```

```

Wrt_Reg_3052(0xFF, 0x30) ;
Wrt_Reg_3052(0xFF, 0x52) ;
Wrt_Reg_3052(0xFF, 0x00) ;
Wrt_Reg_3052(0x36, 0x02) ;
Wrt_Reg_3052(0x53, 0x2c) ;
Wrt_Reg_3052(0x11, 0x00) ;
delay_ms(200) ;
Wrt_Reg_3052(0x29, 0x00) ;
delay_ms(50) ;
}

```

```

Void Sleep in(void)
{
Wrt_Reg_3052(0x28, 0x00) ; //Enter display off
Delaysms (120) ; //Delay 120ms
Wrt_Reg_3052(0x11, 0x00) ; //Enter sleep in
Delaysms (120) ; //Delay 120ms
}

```

```

Void Sleep out(void)
{
Wrt_Reg_3052(0x11, 0x00) ; //Enter sleep out
delay_ms(200) ; //Delay 120ms
Wrt_Reg_3052(0x29, 0x00) ; //Enter display on
Delaysms (120) ; //Delay 120ms
}

```

文档修订记录 Document revision history :

版本 Version	日期 DATE	修改说明 Modify description	编制 PREPARED BY
0-0	2022-11-30	初次编制 First compilation.	YL

-- 结束 --

-- END --